

Cathedral Ventilation System Installation on shingle roofs (new and existing construction)

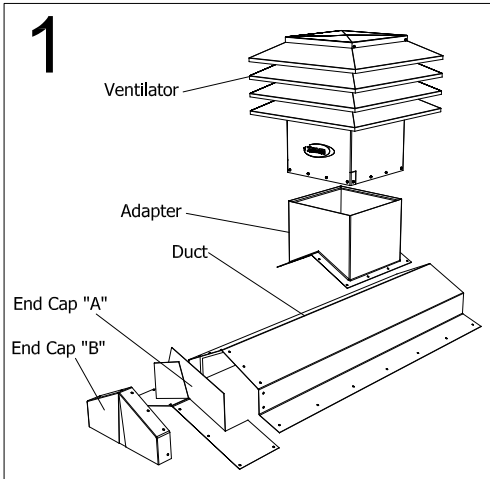

Cathedral Ventilation System Components.

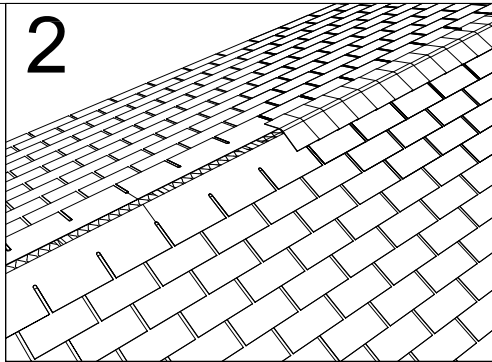

Remove ridge caps shingles complete.

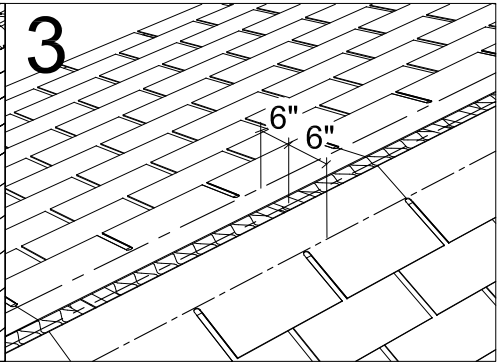

Trace a line 6 inches down each side of the ridge.

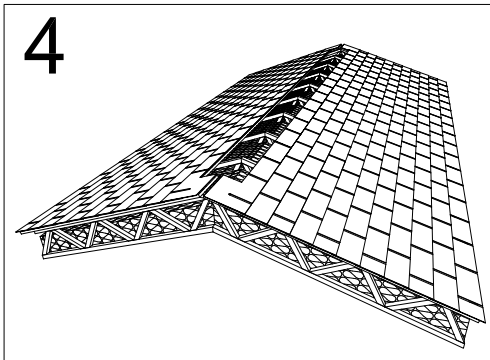

Cut out shingles and deck by following the lines leaving the ridge exposed. Be careful not to cut or interfere with the rafters. Leave the width of the overhang uncut at both extremities.

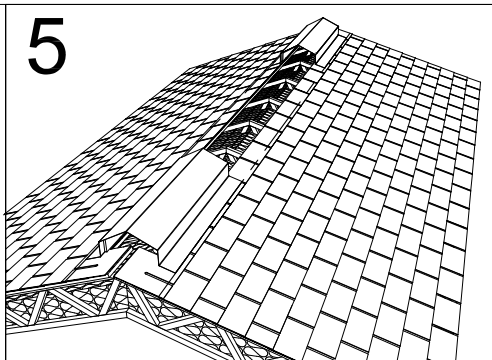

Temporarily install 2 Ducts, one on each extremity, as illustrated. Then trace a line onto the shingles, making sure that they are perfectly aligned.

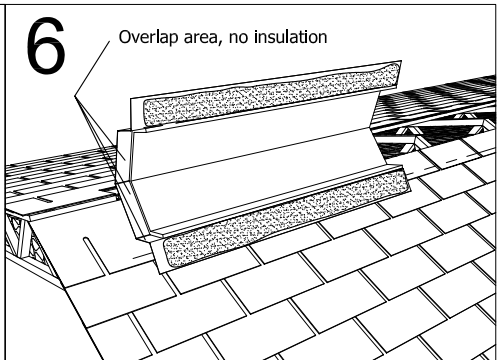

Apply a generous amount of bitumen sealant onto the underside of the duct flashing and secure to deck. Make sure you follow the line on each side. (screws supplied by contractor)

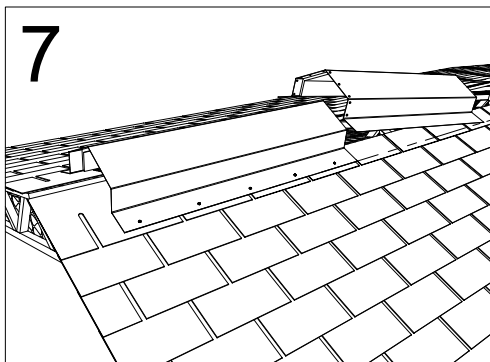

Apply a quality sealant onto the second Duct as per step 6 as well as onto the overlap (as illustrated in the next Step).

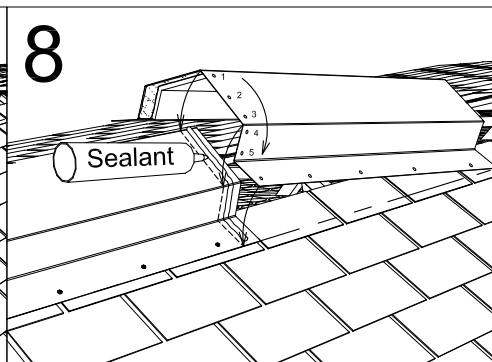

Install the second Duct over the first, overlapping 2 inches and secure together with screws provided. Start screwing from the top (left and right side) down to the vertical sides. Use each of the perforated holes, then secure to deck.

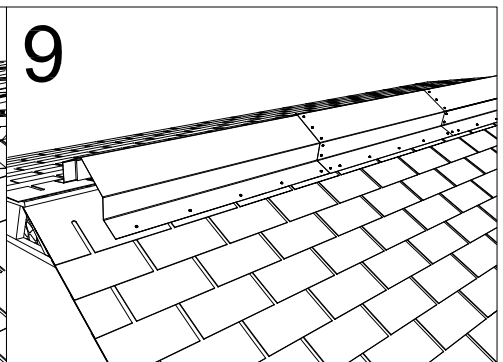

Repeat step 6,7, and 8 for all other Ducts.

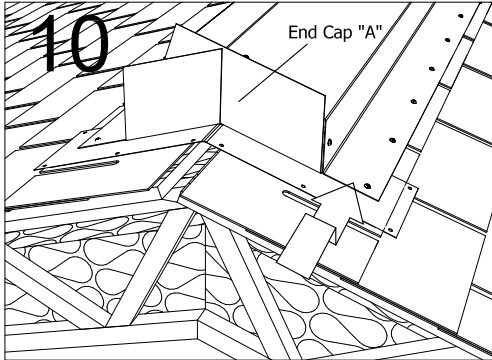

10 Place End Cap "A" onto side of Duct and under the flange, as per illustrated.

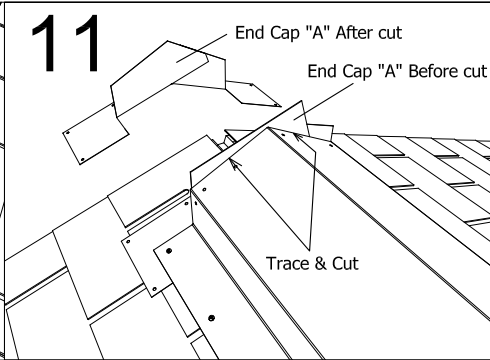

11 Trace and cut out excess metal from End Cap "A". Make sure that metal does not exceed edge of Duct.

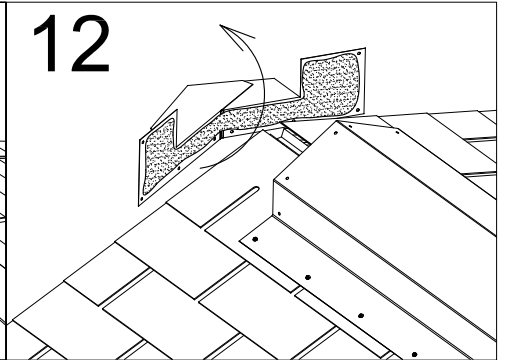

12 Apply a good quality sealant onto the underside of the flashing of End Cap "A".

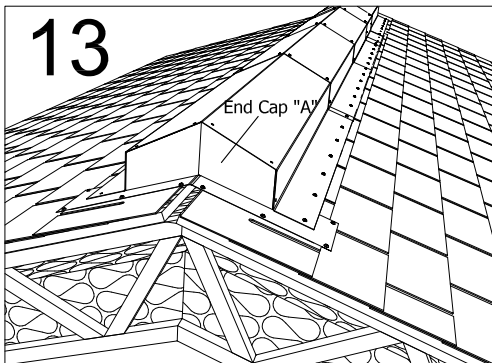

13 Reinstall End Cap "A" onto the Duct and under the flange as per illustrated, and secure to deck. (screws provided by contractor)

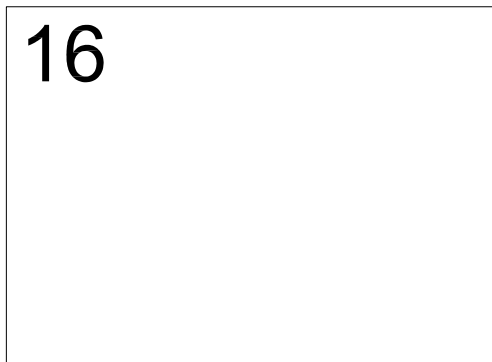
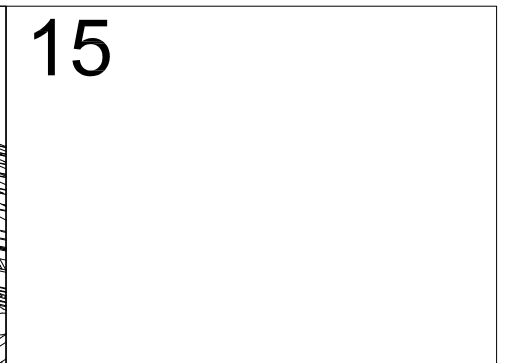
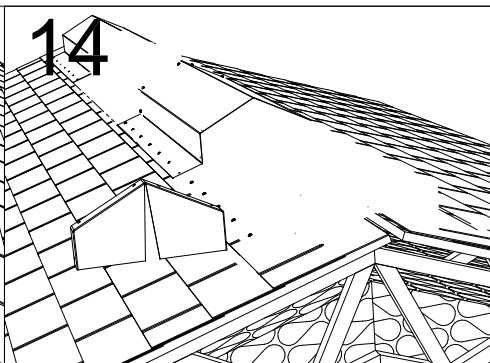

Cathedral Ventilation System Installation on shingle roofs (new and existing construction)

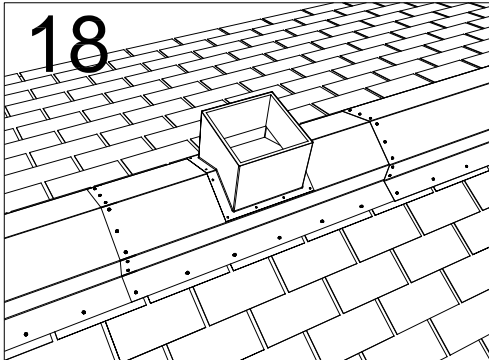

18
Place the Adapter onto the Duct at the desired location, then trace a line onto the Duct, using the interior of the adaptor as your template.

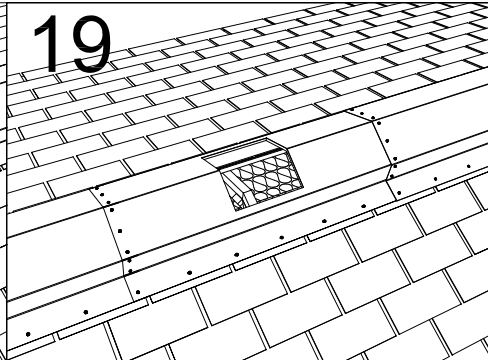

19
Remove the Adapter and cut out the opening as per illustrated.

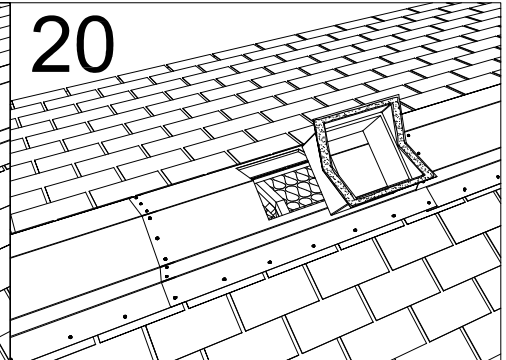

20
Apply a good quality sealant onto the underside flashing of the Adapter, as illustrated.

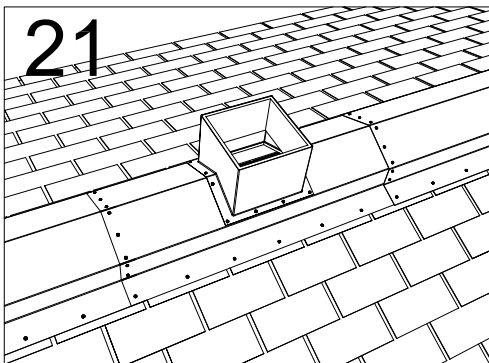

21
Place the Adapter back onto the Duct over the hole and secure to Duct with screws provided into each of the perforations.

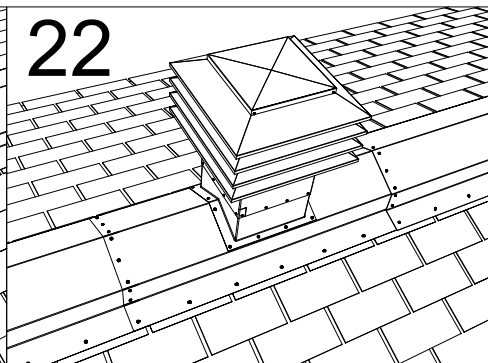

22
Install and secure Ventilator onto the Adapter, making sure it is level.

